

Tail gate thickness	Front panel thickness	Body inside dimensions
5 mm	5 mm	5700 x 2300 x 1450 mm

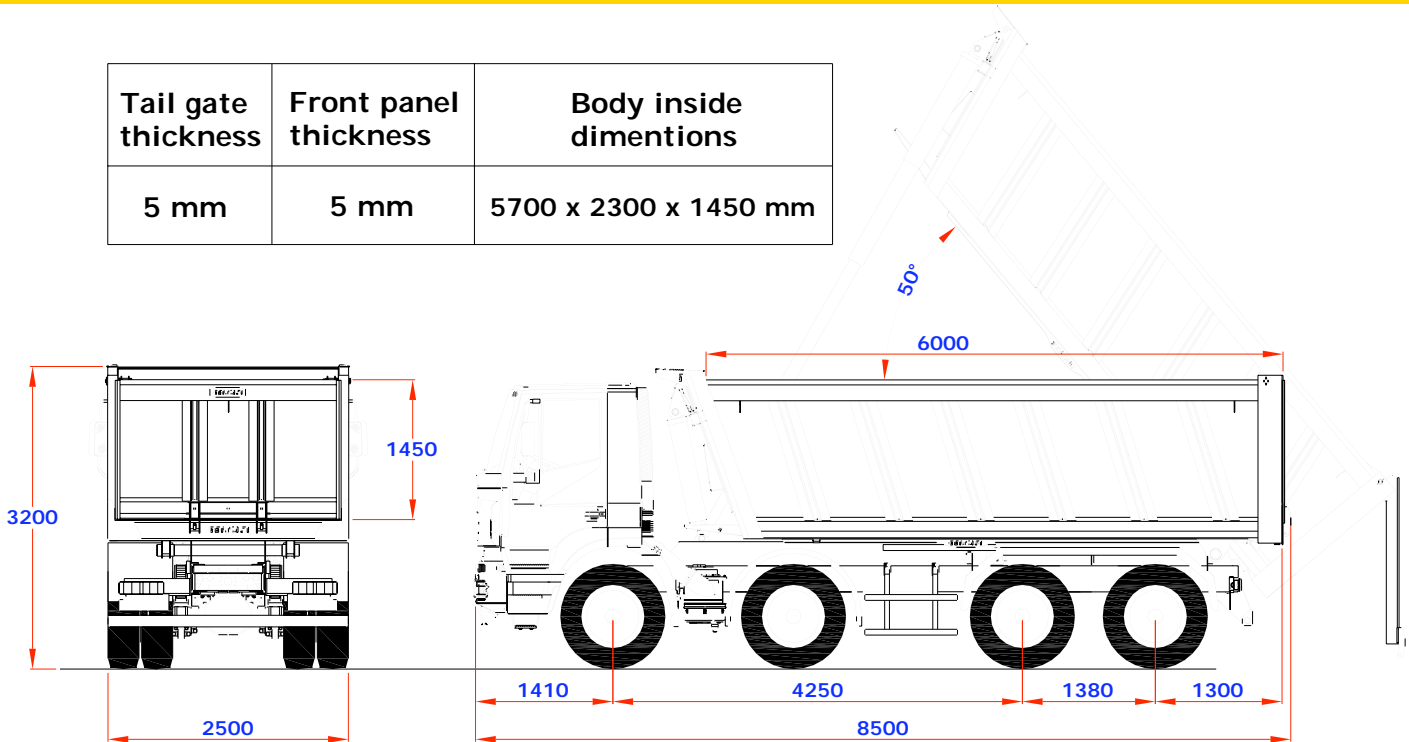

Body Volume	Tipping structure Weight	Total vehicle dead weight including tipping structure and spare wheel	Floor	Side Walls	Body lifting angle
18 mc.	4800 kg.	15600 kg.	HB 450 steel Thickness 8 mm	HB 450 steel Thickness 5 mm	50°

The dimensions and weights are indicative. They can be changed without warning for manufacturing needs. F.lli Gervasi S.p.A.

EMPLOY

- Bulk material (sand, gravel, asphalt,).

TIPPER BODY

- Fixed side walls with welded reinforcements.
- Front board with cab protecting lid.
- Top hinged tail gate with automatic release.
- Tipping control by means of front telescopic hydraulic cylinder.
- Activation by means of pneumatic control from the cab.
- Safety device at rear, bolted to the vehicle frame, complete with rubber body support when lifting.
- Painting:
 - Sandblasting by means of computerised system;
 - Application of polyurethane primer and finishing enamel.
- Painting colour: subframe in RAL 7021, body in customer colour.

STANDARD EQUIPMENTS

- Rear steel mudguards.
- Stainless steel tool box with lock (210 x 500 x 470 mm).
- Spare wheel on the front panel complete with lifting device.
- Side protections, lateral clearance lights.

OPTIONS

- Rear asphalt extension for finisher. (+ 43 kg.)
- Manual tarpaulin. (+ 200 kg.)
- Parking wedges with holders.